

# 2SA1381/KSA1381

## PNP Epitaxial Silicon Transistor

### Applications

- Audio, Voltage Amplifier and Current Source
- CRT Display, Video Output
- General Purpose Amplifier

### Features

- High Voltage :  $V_{CEO} = -300V$
- Low Reverse Transfer Capacitance :  $C_{re} = 2.3pF$  at  $V_{CB} = -30V$
- Excellent Gain Linearity for low THD
- High Frequency: 150MHz
- Full thermal and electrical Spice models are available
- Complement to 2SC3503/KSC3503

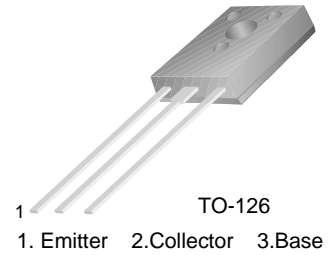

### Absolute Maximum Ratings\* $T_a = 25^\circ C$ unless otherwise noted

Symbol	Parameter	Ratings	Units
$BV_{CBO}$	Collector-Base Voltage	-300	V
$BV_{CEO}$	Collector-Emitter Voltage	-300	V
$BV_{EBO}$	Emitter-Base Voltage	-5	V
$I_C$	Collector Current(DC)	-100	mA
$I_{CP}$	Collector Current(Pulse)	-200	mA
$P_C$	Total Device Dissipation, $T_C=25^\circ C$ $T_C=125^\circ C$	7 1.2	W W
$T_J, T_{STG}$	Junction and Storage Temperature	- 55 ~ +150	$^\circ C$

\* These ratings are limiting values above which the serviceability of any semiconductor device may be impaired.

### Thermal Characteristics\* $T_a=25^\circ C$ unless otherwise noted

Symbol	Parameter	Max.	Units
$R_{\theta JC}$	Thermal Resistance, Junction to Case	17.8	$^\circ C/W$

\* Device mounted on minimum pad size

### $h_{FE}$ Classification

Classification	C	D	E	F
$h_{FE}$	40 ~ 80	60 ~ 120	100 ~ 200	160 ~ 320

**Electrical Characteristics\***  $T_a=25^\circ\text{C}$  unless otherwise noted

Symbol	Parameter	Test Condition	Min.	Typ.	Max.	Units
$BV_{CBO}$	Collector-Base Breakdown Voltage	$I_C = -10\mu\text{A}, I_E = 0$	-300			V
$BV_{CEO}$	Collector- Emitter Breakdown Voltage	$I_C = -1\text{mA}, I_B = 0$	-300			V
$BV_{EBO}$	Emitter-Base Breakdown Voltage	$I_E = -10\mu\text{A}, I_C = 0$	-5			V
$I_{CBO}$	Collector Cut-off Current	$V_{CB} = -200\text{V}, I_E = 0$			-0.1	$\mu\text{A}$
$I_{EBO}$	Emitter Cut-off Current	$V_{EB} = -4\text{V}, I_C = 0$			-0.1	$\mu\text{A}$
$h_{FE}$	DC Current Gain	$V_{CE} = -10\text{V}, I_C = -10\text{mA}$	40		320	
$V_{CE(sat)}$	Collector-Emitter Saturation Voltage	$I_C = -20\text{mA}, I_B = -2\text{mA}$			-0.6	V
$V_{BE(sat)}$	Base-Emitter Saturation Voltage	$I_C = -20\text{mA}, I_B = -2\text{mA}$			-1	V
$f_T$	Current Gain Bandwidth Product	$V_{CE} = -30\text{V}, I_C = -10\text{mA}$		150		MHz
$C_{ob}$	Output Capacitance	$V_{CB} = -30\text{V}, f = 1\text{MHz}$		3.1		pF
$C_{re}$	Reverse Transfer Capacitance	$V_{CB} = -30\text{V}, f = 1\text{MHz}$		2.3		pF

\* Pulse Test: Pulse Width $\leq$ 300 $\mu\text{s}$ , Duty Cycle $\leq$ 2%**Ordering Information**

Part Number*	Marking	Package	Packing Method	Remarks
2SA1381CSTU	2SA1381C	TO-126	TUBE	hFE1 C grade
2SA1381DSTU	2SA1381D	TO-126	TUBE	hFE1 D grade
2SA1381ESTU	2SA1381E	TO-126	TUBE	hFE1 E grade
2SA1381FSTU	2SA1381F	TO-126	TUBE	hFE1 F grade
KSA1381CSTU	A1381C	TO-126	TUBE	hFE1 C grade
KSA1381DSTU	A1381D	TO-126	TUBE	hFE1 D grade
KSA1381ESTU	A1381E	TO-126	TUBE	hFE1 E grade
KSA1381FSTU	A1381F	TO-126	TUBE	hFE1 F grade

\* 1. Affix "-S-" means the standard TO126 Package.(see package dimensions). If the affix is "-STS-" instead of "-S-", that mean the short-lead TO126 package.  
 2. Suffix "-TU" means the tube packing. The Suffix "TU" could be replaced to other suffix character as packing method.

## Typical Characteristics

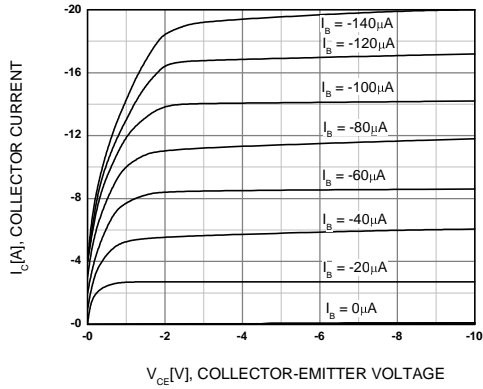

**Figure 1. Static Characteristic**

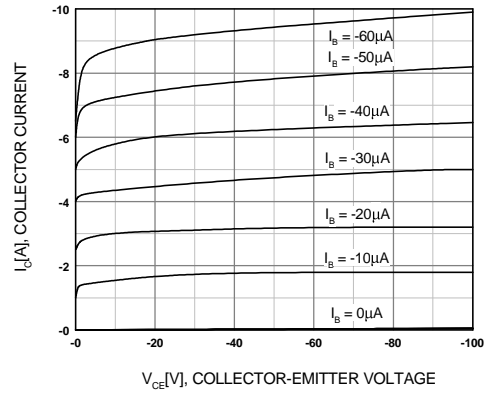

**Figure 2. Static Characteristic**

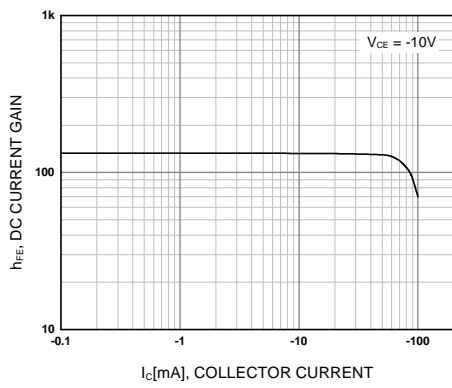

**Figure 3. DC current Gain**

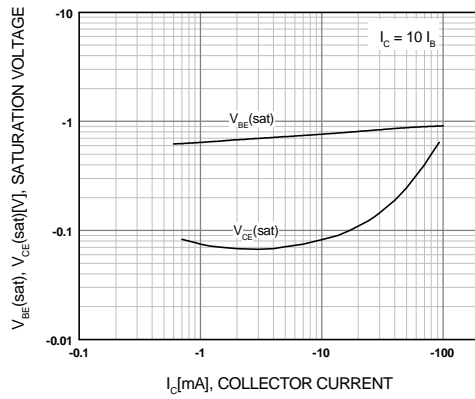

**Figure 4. Base-Emitter Saturation Voltage  
Collector-Emitter Saturation Voltage**

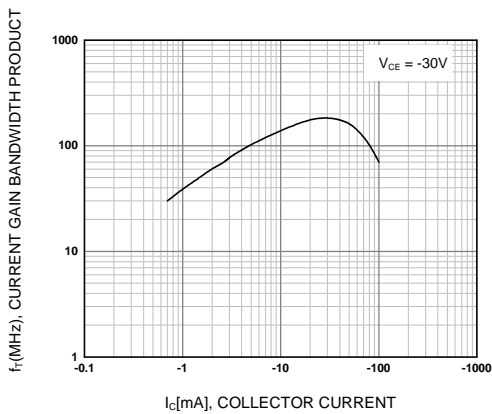

**Figure 5. Current Gain Bandwidth Product**

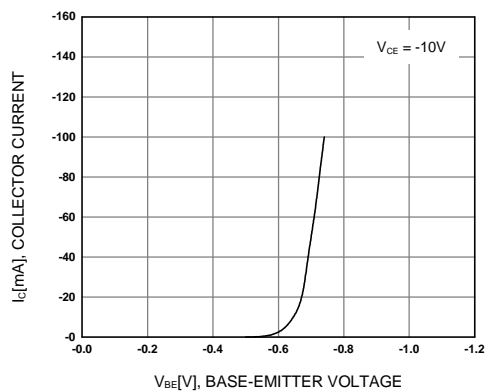

**Figure 6. Base-Emitter On Voltage**

Typical Characteristics (Continued)

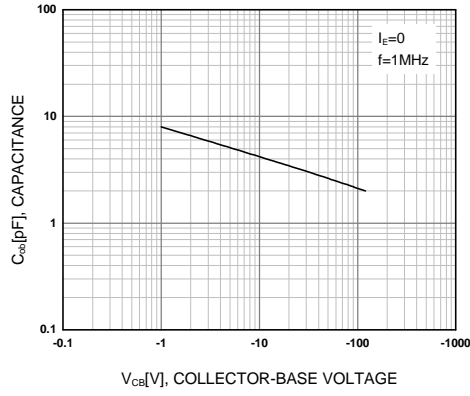

Figure 7. Collector Output Capacitance

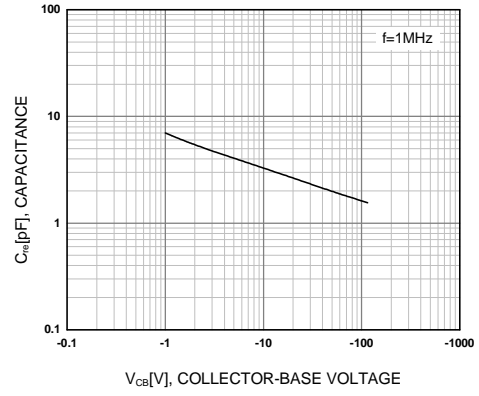

Figure 8. Reverse Transfer Capacitance

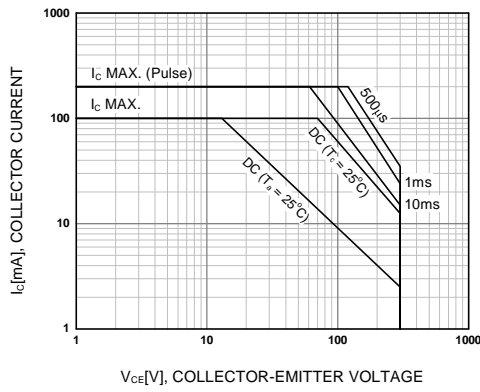

Figure 9. Safe Operating Area

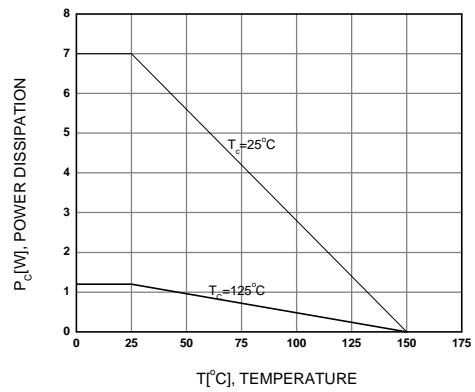
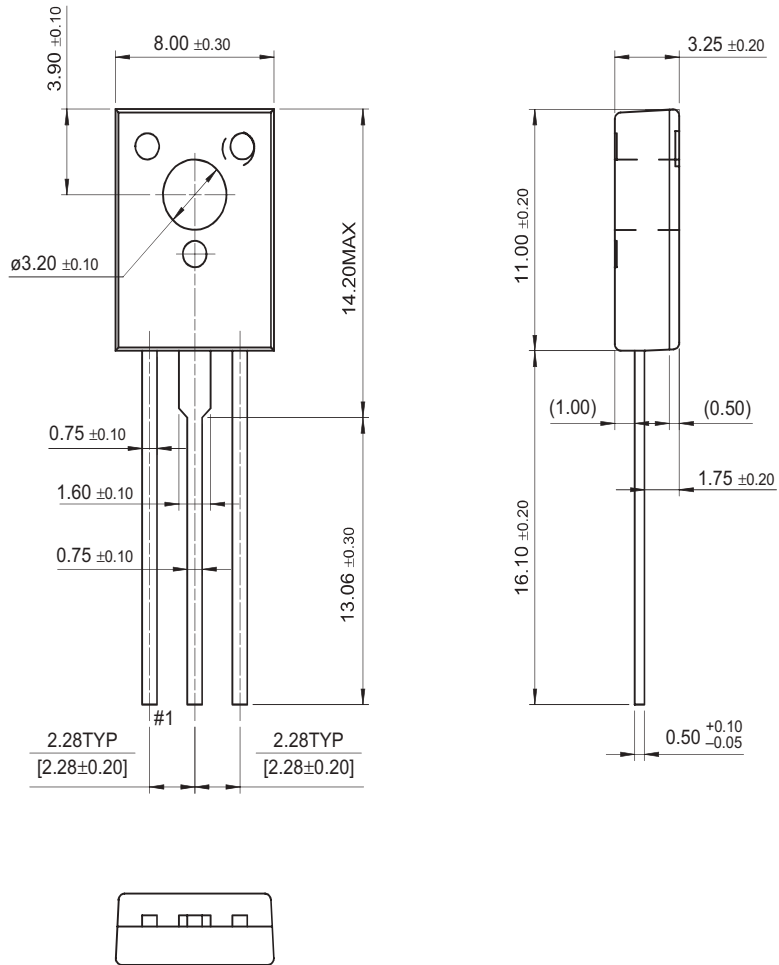

Figure 10. Power Derating

# Package Dimensions

## TO-126



Dimensions in Millimeters



**TRADEMARKS**

The following are registered and unregistered trademarks and service marks Fairchild Semiconductor owns or is authorized to use and is not intended to be an exhaustive list of all such trademarks.

- |  |  |                            |   |
|--|--|----------------------------|---|
| ACEx®  | Green FPS™   | Power247®                  | SuperSOT™-8   |
| Build it Now™  | Green FPS™ e-Series™   | POWEREDGE®                 | SyncFET™  |
| CorePLUS™  | GTO™   | Power-SPM™                 | The Power Franchise®  |
| CROSSVOLT™   | i-Lo™  | PowerTrench®               |  |
| CTL™   | IntelliMAX™  | Programmable Active Droop™ | TinyBoost™  |
| Current Transfer Logic™  | ISOPLANAR™   | QFET®                      | TinyBuck™   |
| EcoSPARK®  | MegaBuck™  | QS™                        | TinyLogic®  |
|  Fairchild® | MICROCOUPLER™  | QT Optoelectronics™        | TINYOPTO™   |
| Fairchild Semiconductor®   | MicroFET™  | Quiet Series™              | TinyPower™  |
| FACT Quiet Series™   | MicroPak™  | RapidConfigure™            | TinyPWM™  |
| FACT®  | MillerDrive™   | SMART START™               | TinyWire™   |
| FAST®  | Motion-SPM™  | SPM®                       | µSerDes™  |
| FastvCore™   | OPTOLOGIC®   | STEALTH™                   | UHC®  |
| FPS™   | OPTOPLANAR®  | SuperFET™                  | UniFET™   |
| FRFET®   |  PDP-SPM™ | SuperSOT™-3                | VCX™  |
| Global Power Resource <sup>SM</sup>  | Power220®  | SuperSOT™-6                |   |

**DISCLAIMER**

FAIRCHILD SEMICONDUCTOR RESERVES THE RIGHT TO MAKE CHANGES WITHOUT FURTHER NOTICE TO ANY PRODUCTS HEREIN TO IMPROVE RELIABILITY, FUNCTION, OR DESIGN. FAIRCHILD DOES NOT ASSUME ANY LIABILITY ARISING OUT OF THE APPLICATION OR USE OF ANY PRODUCT OR CIRCUIT DESCRIBED HEREIN; NEITHER DOES IT CONVEY ANY LICENSE UNDER ITS PATENT RIGHTS, NOR THE RIGHTS OF OTHERS. THESE SPECIFICATIONS DO NOT EXPAND THE TERMS OF FAIRCHILD'S WORLDWIDE TERMS AND CONDITIONS, SPECIFICALLY THE WARRANTY THEREIN, WHICH COVERS THESE PRODUCTS.

**LIFE SUPPORT POLICY**

FAIRCHILD'S PRODUCTS ARE NOT AUTHORIZED FOR USE AS CRITICAL COMPONENTS IN LIFE SUPPORT DEVICES OR SYSTEMS WITHOUT THE EXPRESS WRITTEN APPROVAL OF FAIRCHILD SEMICONDUCTOR CORPORATION.

As used herein:

- Life support devices or systems are devices or systems which, (a) are intended for surgical implant into the body, or (b) support or sustain life, and (c) whose failure to perform when properly used in accordance with instructions for use provided in the labeling, can be reasonably expected to result in significant injury to the user.
- A critical component is any component of a life support device or system whose failure to perform can be reasonably expected to cause the failure of the life support device or system, or to affect its safety or effectiveness.

**PRODUCT STATUS DEFINITIONS**

**Definition of Terms**

Datasheet Identification	Product Status	Definition
Advance Information	Formative or In Design	This datasheet contains the design specifications for product development. Specifications may change in any manner without notice.
Preliminary	First Production	This datasheet contains preliminary data; supplementary data will be published at a later date. Fairchild Semiconductor reserves the right to make changes at any time without notice to improve design.
No Identification Needed	Full Production	This datasheet contains final specifications. Fairchild Semiconductor reserves the right to make changes at any time without notice to improve design.
Obsolete	Not In Production	This datasheet contains specifications on a product that has been discontinued by Fairchild semiconductor. The datasheet is printed for reference information only.